



\*\*\*\*\*

### HIGH POWER THYRISTOR FOR INVERTER APPLICATION

#### Features:

- . All Diffused Structure
- . Amplifying Gate Configuration
- . Blocking capability up to 1400 volts
- . High dv/dt Capability
- . Pressure Assembled Device

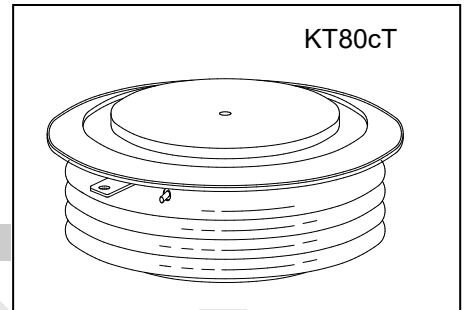

### ELECTRICAL CHARACTERISTICS AND RATINGS

#### Blocking-Off State

Device Type	V <sub>RRM</sub> (1)	V <sub>DRM</sub> (1)	V <sub>RSM</sub> (1)
KK3000/12	1200	1200	1400
KK3000/14	1400	1400	1600

V<sub>RRM</sub> = Repetitive peak reverse voltage

V<sub>DRM</sub> = Repetitive peak off state voltage

V<sub>RSM</sub> = Non Repetitive peak reverse voltage(2)

Repetitive peak reverse leakage and off state leakage	I <sub>RRM</sub> /I <sub>DRM</sub>	2 mA 20 mA (3)
Critical rate of voltage rise	dv/dt (4)	1000 V/sec (min)

#### Notes:

All ratings are specified for T<sub>j</sub>=25 °C unless otherwise stated.

(1) All voltage ratings are specified for an applied 50Hz/60zHz sinusoidal waveform over the temperature range 0 to +125 °C

(2) 10 msec. Max. Pulse width

(3) Maximum value for T<sub>j</sub>=125 °C.

(4) Minimum value for linear and exponential waveshape to 67% rated V<sub>DRM</sub>. Gate open, T<sub>j</sub>=125 °C

(5) The value of di/dt is established in accordance with JB/T4193-2013.

#### Conducting-On State

Parameter	Symbol	Min.	Max.	Typ.	Units	Conditions
Average value of on-state current	I <sub>T(AV)</sub>		3000		A	Sinewave, 180° conduction, T <sub>c</sub> =55°C
RMS value of on-state current	I <sub>TRMS</sub>		4710		A	Nominal value
Peak one cycle surge (non repetitive) current	I <sub>TSM</sub>		42000		A	10 msec (50Hz), sinusoidal wave-shape, 180° conduction, T <sub>j</sub> = 125 °C
I square t	I <sup>2</sup> t		8.8x10 <sup>6</sup>		A <sup>2</sup> s	10 msec
Latching current	I <sub>L</sub>		1000		mA	V <sub>D</sub> =12V; R <sub>L</sub> =12ohms
Holding current	I <sub>H</sub>		200		mA	V <sub>D</sub> =12V; I=2.5A
Peak on-state voltage	V <sub>TM</sub>		1.60		V	I <sub>TM</sub> = 3000A; T <sub>j</sub> =25°C
Threshold voltage, low-level	V <sub>TO</sub>		1.24		V	T <sub>j</sub> =125°C
Slope resistance, low-level	r <sub>T</sub>		0.12		mΩ	3000 A to 5500A
Critical rate of rise of on-state current(5)	di/dt		200		A/μs	Repetition

### Gating

Parameter	Symbol	Min.	Max.	Typ.	Units	Conditions
Peak gate power dissipation	$P_{GM}$		20		W	
Average gate power dissipation	$P_{G(AV)}$		4		W	
Gate trigger current	$I_{GT}$		200	150	mA	$V_D=12V; R_L=3ohms; T_j=+25^{\circ}C$
Gate trigger voltage	$V_{GT}$	0.70	3.0	2.5	V	$V_D=12V; R_L=3ohms; T_j=+25^{\circ}C$
Peak negative voltage	$V_{GRM}$		5		V	

### Dynamic

Parameter	Symbol	Min.	Max.	Typ.	Units	Conditions
Delay time	$t_d$		3.0	2.5	$\mu s$	$I_{TM}=50A; V_D=67\%V_{DRM}$ Gate pulse: $V_G=30V; R_G=10ohms;$ $t_r=0.1\mu s; t_p=20\mu s$
Turn-off time ( $V_R=-5V$ )	$t_q$		22		$\mu s$	$I_{TM}=2000 A; di/dt=-10 A/\mu s;$ $V_R=50 V; dV/dt=30V/\mu s;$ $V_D=67\%V_{DRM}; T_j=125^{\circ}C$
Reverse recovery current	$Q_{rr}$				$\mu C$	$I_{TM}=2000 A; di/dt=-10A/\mu s;$ $V_R=50 V; T_j=125^{\circ}C$

### THERMAL AND MECHANICAL CHARACTERISTICS AND RATINGS

Parameter	Symbol	Min.	Max.	Typ.	Units	Conditions
Operating temperature	$T_j$	-40	+125		$^{\circ}C$	
Storage temperature	$T_{stg}$	-40	+140		$^{\circ}C$	
Thermal resistance-junction to case	$R_{\theta(j-c)}$		0.01		$^{\circ}C/W$	Double sided cooled
Thermal resistance - case to heatsink	$R_{\theta(c-s)}$		0.003		$^{\circ}C/W$	Double sided cooled
Mounting force	P			35	kN	
Weight	W			1.10	kg.	

\* Mounting surfaces smooth, flat and greased

