

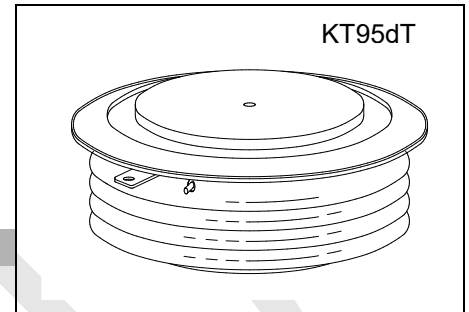

FREE FLOATING TYPE THYRISTOR FOR PHASE CONTROL APPLICATIONS

Features:

- . Free-floating silicon technology
- . Low on-state and switching losses
- . Optimum power handling capability
- . Blocking capability up to 7200 volts
- . Distributed amplifying gate



ELECTRICAL CHARACTERISTICS AND RATINGS

Blocking - Off State

Device Type	V _{RRM} (1)	V _{DRM} (1)	V _{RSM} (1)
KP1510/68	6800	6800	6800
KP1510/70	7000	7000	7000
KP1510/72	7200	7200	7200

V_{RRM} = Repetitive peak reverse voltage
 V_{DRM} = Repetitive peak off state voltage
 V_{RSM} = Non repetitive peak reverse voltage (2)

Notes:

- (1) All voltage ratings are specified for an applied 50Hz/60Hz sinusoidal waveform over the temperature range 0 to +125 °C.
- (2) 10 msec. max. pulse width
- (3) Maximum value for T_j = 125 °C.
- (4) Minimum value for linear and exponential waveshape to 67% rated V_{DRM}. Gate open. T_j = 125 °C.
- (5) The value of di/dt is established in accordance with JB/T 8950.2-2013

Repetitive peak reverse leakage and off state leakage	I _{RRM} /I _{DRM}	10mA 100 mA (3)
Critical rate of voltage rise	d _v /d _t (4)	2000 V/sec (min)

Conducting - On State

Parameter	Symbol	Min.	Max.	Typ.	Units	Conditions
Average value of on-state current	I _{T(AV)}		1510		A	Sinewave, 180° conduction, T _c =70°C
RMS value of on-state current	I _{TRMS}		2370		A	Nominal value
Peak one cycle surge (non repetitive) current	I _{TSM}		26000		A	10.0 msec (50Hz), sinusoidal waveshape, 180° conduction, T _j = 125 °C
I square t	I ² t		3.3x10 ⁶		A ² s	10 msec
Latching current	I _L		1000		mA	V _D = 12 V; R _L = 12 ohms
Holding current	I _H		200		mA	V _D = 12 V; I = 2.5 A
Peak on-state voltage	V _{TM}		2.00		V	I _{TM} =1600A; T _j =25°C
Threshold voltage, low-level	V _{TO}		1.20		V	T _j =125°C
Slope resistance, low-level	r _T		0.50		mΩ	500A to1500A
Critical rate of rise of on-state current	di/dt		100		A/μs	Repetition

Gating

Parameter	Symbol	Min.	Max.	Typ.	Units	Conditions
Peak gate power dissipation	P_{GM}		20		W	
Average gate power dissipation	$P_{G(AV)}$		4		W	
Gate-trigger current	I_{GT}		300		mA	$V_D = 12\text{ V}; R_L = 3\text{ ohms}; T_j = +25\text{ }^\circ\text{C}$
Gate- trigger voltage	V_{GT}	0.8	3.0		V	$V_D = 12\text{ V}; R_L = 3\text{ ohms}; T_j = +25\text{ }^\circ\text{C}$
Peak negative voltage	V_{GRM}		10		V	

Dynamic

Parameter	Symbol	Min.	Max.	Typ.	Units	Conditions
Delay time	t_d		3.0		μs	$I_{FG}=2.0\text{A}; V_D=0.4V_{DRM}; t_r=0.5\mu\text{s}$
Turn-off time (with $V_R = -5\text{ V}$)	t_q		800		μs	$I_{TM}=1000\text{ A}; di/dt = -10\text{A}/\mu\text{s}; V_R = 100\text{ V}; dV/dt=30\text{V}/\mu\text{s}; V_D= 67\%V_{DRM}; T_j=125^\circ\text{C}$
Reverse recovery charge	Q_{rr}		2000		μC	$I_{TM}=1000\text{A}; di/dt=-1\text{ A/s}; V_R=100\text{ V}; T_j=125^\circ\text{C}$

THERMAL AND MECHANICAL CHARACTERISTICS AND RATINGS

Parameter	Symbol	Min.	Max.	Typ.	Units	Conditions
Operating temperature	T_j	-40	+125		$^\circ\text{C}$	
Storage temperature	T_{stg}	-40	+140		$^\circ\text{C}$	
Thermal resistance - junction to case	$R_{\Theta(j-c)}$		0.008		$^\circ\text{C}/\text{W}$	Double sided cooled
Thermal resistance - case to heatsink	$R_{\Theta(c-s)}$		0.002		$^\circ\text{C}/\text{W}$	Double sided cooled
Mounting force	P			70	kN	
Weight	W			1.85	kg	

* Mounting surfaces smooth, flat and greased

