



\*\*\*\*\*

### FREE FLOATING TYPE THYRISTOR FOR PHASE CONTROL APPLICATIONS

#### Features:

- . Free-floating silicon technology
- . Low on-state and switching losses
- . Optimum power handling capability
- . Blocking capability up to 8500 volts
- . Distributed amplifying gate

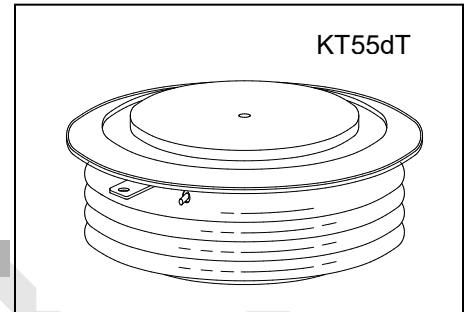

### ELECTRICAL CHARACTERISTICS AND RATINGS

#### Blocking - Off State

Device Type	V <sub>RRM</sub> (1)	V <sub>DRM</sub> (1)	V <sub>RSM</sub> (1)
KP580/74	7400	7400	7400
KP580/80	8000	8000	8000
KP580/85	8500	8500	8500

V<sub>RRM</sub> = Repetitive peak reverse voltage  
 V<sub>DRM</sub> = Repetitive peak off state voltage  
 V<sub>RSM</sub> = Non repetitive peak reverse voltage (2)

#### Notes:

- (1) All voltage ratings are specified for an applied 50Hz/60Hz sinusoidal waveform over the temperature range 0 to +115 °C.
- (2) 10 msec. max. pulse width
- (3) Maximum value for T<sub>j</sub> = 115 °C.
- (4) Minimum value for linear and exponential waveshape to 67% rated V<sub>DRM</sub>. Gate open. T<sub>j</sub> = 115 °C.
- (5) The value of di/dt is established in accordance with JB/T 8950.2-2013

Repetitive peak reverse leakage and off state leakage	I <sub>RRM</sub> /I <sub>DRM</sub>	10mA 100 mA (3)
Critical rate of voltage rise	d <sub>v</sub> /d <sub>t</sub> (4)	2000 V/sec (min)

#### Conducting - On State

Parameter	Symbol	Min.	Max.	Typ.	Units	Conditions
Average value of on-state current	I <sub>T(AV)</sub>		580		A	Sinewave, 180° conduction, T <sub>c</sub> =70°C
RMS value of on-state current	I <sub>TRMS</sub>		910		A	Nominal value
Peak one cycle surge (non repetitive) current	I <sub>TSM</sub>		6000		A	10.0 msec (50Hz), sinusoidal waveshape, 180° conduction, T <sub>j</sub> = 115 °C
I square t	I <sup>2</sup> t		1.8x10 <sup>5</sup>		A <sup>2</sup> s	10 msec
Latching current	I <sub>L</sub>		1000		mA	V <sub>D</sub> = 12 V; R <sub>L</sub> = 12 ohms
Holding current	I <sub>H</sub>		200		mA	V <sub>D</sub> = 12 V; I = 2.5 A
Peak on-state voltage	V <sub>TM</sub>		2.60		V	I <sub>TM</sub> =1000A; T <sub>j</sub> =25°C
Threshold voltage, low-level	V <sub>TO</sub>		1.30		V	T <sub>j</sub> =115°C
Slope resistance, low-level	r <sub>T</sub>		1.50		mΩ	300A to1000A
Critical rate of rise of on-state current	di/dt		100		A/μs	Repetition

**Gating**

Parameter	Symbol	Min.	Max.	Typ.	Units	Conditions
Peak gate power dissipation	$P_{GM}$		20		W	
Average gate power dissipation	$P_{G(AV)}$		4		W	
Gate-trigger current	$I_{GT}$		300		mA	$V_D = 12\text{ V}; R_L = 3\text{ ohms}; T_j = +25\text{ }^\circ\text{C}$
Gate- trigger voltage	$V_{GT}$	0.8	3.0		V	$V_D = 12\text{ V}; R_L = 3\text{ ohms}; T_j = +25\text{ }^\circ\text{C}$
Peak negative voltage	$V_{GRM}$		10		V	

**Dynamic**

Parameter	Symbol	Min.	Max.	Typ.	Units	Conditions
Delay time	$t_d$		3.0		$\mu\text{s}$	$I_{FG}=2.0\text{A}; V_D=0.4V_{DRM}; t_r=0.5\mu\text{s}$
Turn-off time (with $V_R = -5\text{ V}$ )	$t_q$		800		$\mu\text{s}$	$I_{TM}=1000\text{ A}; di/dt = -10\text{A}/\mu\text{s}; V_R = 100\text{ V}; dV/dt=30\text{V}/\mu\text{s}; V_D= 67\%V_{DRM}; T_j=115^\circ\text{C}$
Reverse recovery charge	$Q_{rr}$		2000		$\mu\text{C}$	$I_{TM}=1000\text{A}; di/dt=-1\text{ A/s}; V_R=100\text{ V}; T_j=115^\circ\text{C}$

**THERMAL AND MECHANICAL CHARACTERISTICS AND RATINGS**

Parameter	Symbol	Min.	Max.	Typ.	Units	Conditions
Operating temperature	$T_j$	-40	+115		$^\circ\text{C}$	
Storage temperature	$T_{stg}$	-40	+115		$^\circ\text{C}$	
Thermal resistance - junction to case	$R_{\Theta(j-c)}$		0.022		$^\circ\text{C}/\text{W}$	Double sided cooled
Thermal resistance - case to heatsink	$R_{\Theta(c-s)}$		0.005		$^\circ\text{C}/\text{W}$	Double sided cooled
Mounting force	P			22	kN	
Weight	W			0.65	kg	

\* Mounting surfaces smooth, flat and greased

